

VOTRONIC

Installation and Operating Manual

Charging Converter, B2B Battery to Battery, battery charging while driving:

VCC 1224-25 IUoU Input Voltage 12V Charging Capacity 24 V / 25 A **No. 3311**

VCC 2424-25 IUoU Input Voltage 24V Charging Capacity 24 V / 25 A **No. 3313**

NOTE: The values indicated in parentheses () apply to units with 24 V input or output.



Please completely read this operating and installation manual thoroughly prior to connection and start-up, in particular "Safety Regulations and Appropriate Application", s. page 2.

Fully Automated Battery Charging Converter for special purpose vehicles, campers, boats.

The charging converters (**Boosters**) have been developed according to the latest regulations for supply battery charging (board battery) with **lead-acid, lead-gel or lead-AGM technology during a drive.**

In case of long supply lines or insufficient cross-sections of the cables, the charging voltage will be increased according to the default charging values so that losses can be compensated. Charging converters with 24 V input voltage allow charging of the 12 V supply battery without installation of a second alternator.

Thus, the charging converter ensures the known high-quality battery charging of the VOTRONIC chargers also while driving. Due to the intelligent microprocessor charging control with characteristic lines of charging „IU1oU2“ and dynamic charging time calculation an automatic, quick and gentle full charging is ensured, as well as subsequent 100 % trickle charge for the connected batteries in any charging state. At the same time, simultaneous supply of 24 V loads, which are connected in parallel, is ensured. Overcharging or excessive gassing of the batteries is avoided, even in case of extremely long driving times.

The charging converters of series „IUoU“ are characterized by their compact design, low weight (high-frequency switching transmitter, switch mode technology), powerfully dimensioned power components and consequently full charging capacity, even with long charging cables or strong voltage variations at the starter battery (**Euro-norm 6, 6 + plus vehicles, energy recuperation**), see page 11, table 2, switch setting "D".

Battery Port and Charging Programs:

Output to board battery, depending on the type of battery, 4 charging programs selectable (see table 1):

- „Gel“: Sealed, gas-proof **Gel** batteries (dryfit, determined electrolyte)
- „AGM1“: Sealed, gas-proof **AGM** batteries (absorbed glass mat, lead-fleece technology)
max. charging voltage **14,7 V !** x2.
- „AGM2“: Sealed, gas-proof **AGM** batteries (absorbed glass mat, lead-fleece technology)
max. charging voltage **14,4 V** x2.
- „Lead Acid“: Closed and wet **acid/lead-acid** lead batteries (factory adjustment)

Further Characteristics of the Unit:

- The **charging voltage** is **free from peaks** and **controlled** in such a way, that any **overcharging** of the batteries is **excluded**.
- Fully automated operation** by switching input (ignition, running motor), as well as voltage control.
- Automatic, adjustable power control** enables the priority to charging of the starter battery by the alternator in case of overloaded vehicle mains to ensure that the vehicle can be started at any time.
- No discharge** (current 0.000 A) of the batteries during stand-by or while charging converter is switched off.
- Parallel and Buffering Operation:** In case of simultaneous consumption, charging of the battery is continued or trickle charging is effected. The charging converter calculates and controls the adaptation of the charging time automatically.
- Unattended Charging:** Multiple protection against overload, overheating, overvoltage, short circuit, reverse polarity at the output, incorrect behavior and back discharge of the battery by electronically controlled gradual reduction down to complete separation of charging converter and battery **through integrated safety relays**.
- Galvanic isolation between input and output:** Complete separation of the battery circuits, even in case of failure, and neat ground ratio for long supply lines.
Particularly important to charging of 24 V systems from 12 V system voltage.

- **Charging Cable Compensation:** Automatic compensation of voltage losses on the charging cables.
- **Charging aid for completely discharged batteries:** Gentle preliminary charging from 0 V to 16 V, followed by powerful support of the battery, in case of possible switched-on loads.
- **Integrated On-board Mains Suppression Filter:** Unproblematic parallel operation of solar systems, wind and petrol-driven generators, mains supply chargers etc. with a single battery.
- **Temperature Compensation:** The charging voltage automatically adapts to the battery temperature **by means of an external temperature sensor** (Order No. 2001). **In case of low outside temperatures, full charging of the weaker battery is improved**, and in case of summery temperatures **unnecessary battery gassing** will be avoided. **This is highly recommended, if the battery (batteries) is (are) exposed to strong variations in temperature, such as in the motor compartment or in the storage space.**



Lifetime of the battery:

- Keep batteries cool; choose an appropriate location for installation.
- **Open acid batteries („maintenance-free according to EN / DIN“):**
Check the acid level periodically!
 - **Batteries that are completely discharged should be recharged immediately, partially discharged batteries should be recharged fully as soon as possible to avoid sulphation!**
 - **Store only fully charged batteries and recharge them periodically**, particularly in case of older, used batteries and in case of higher temperatures! If the grade of sulphation is not too intensive, the battery can recover part of the battery capacity after several charging/discharging cycles.



Safety Regulations and Appropriate Application:

The charging converter has been designed according to the valid safety regulations.

Appropriate application is restricted to:

1. **Charging lead-acid, lead-gel or lead-AGM batteries with the indicated nominal voltage and the supply of the consumer loads being connected to these batteries in fixed installed systems with the indicated battery capacities and charging programs.**
2. **Connection according to the indicated cable cross-sections at the inputs and outputs of the charging converter.**
3. **With the specified battery capacity at the inputs and outputs of the charging converter.**
4. **Providing fuses of the indicated capacity near the battery to protect the cabling between battery and connections of the charging converter.**
5. **Technically faultless condition.**
6. **Installation in a well-ventilated room, protected from rain, humidity, dust, aggressive battery gas, as well as in an environment being from condensation.**

The unit must never used at any location that holds a risk for gas- or dust explosions!

- Do not operate the unit outdoors.
- Lay the cables in a way, that damage is avoided. Make sure to fasten them tightly. Never lay 12 V (24 V) cables and 230 V mains supply cables into the same cable conduit (empty conduit).
- Cables or leads that carry voltage must be checked periodically for insulation faults, points of break or loosened connections. Occurring defects must be corrected immediately.
- The unit is to be disconnected from any connection prior to executing electrical welding or working on the electric system.
- If the non-commercial end-user is not able to recognize the characteristic values that are valid for the unit or the regulations that have to be followed, a specialist is always to be consulted.
- The user/buyer is obliged to observe any construction and safety regulations.
- **The unit does not contain any parts, which can be replaced by the user.** Even after having been switched-off, the unit may still contain voltage for an extended period (particularly in case of failure).
- Keep children away from the charging converter and the batteries.
- Pay attention to the safety regulations of the battery manufacturer; ventilate the battery room.
- Non-observance may result in physical injuries or material damages.
- The warranty period is 36 months from the purchase date (upon presentation of the sales slip or invoice).
- The warranty will be void in case of any inappropriate utilization of the unit, if it is used beyond the technical specifications, in case of improper operation or external interference. We do not assume any liability for any damage resulting hereof. The liability exclusion is extended to any service being executed by third, which has not been ordered by us in writing. Service is to be effected exclusively by VOTRONIC Lauterbach.

Installation of the Unit:

The charging converter can be installed at any location, which is clean and protected from humidity and dust on an even and hard mounting surface. Choose an installation location ensuring that the length of the connection cable between starter battery (IN) and board battery (OUT) is as short as possible. Thereby, unnecessary losses from the cables are avoided.

Despite the charging converter's high efficiency, heat is produced, which is brought out of the casing by means of the built-in fans.

Ensure sufficient **ventilation** in the **environment of the unit**, so that the heat can be carried-off. Protect the unit from aggressive battery gas.

The unit can be installed in any position. However, the **vent holes** of the casing (front panel and rear panel) should never be covered in order to ensure the full charging capacity (**minimum distance: 10 cm**).

Battery Connection and -Settings for Start-up:

Follow the connection plan! Follow the cable cross-section and length, as well as the polarization, and use cable protection for the cables near the battery.

Connect the charging converter first, then the batteries.

1. Connect the board battery to the terminals „Battery I **OUT**“ „-“ and „+“ observing the **correct polarity**.
2. Connect the terminal “Sense Out” from the voltage sensor line directly to the positive pole of the board battery. Protect the line by a protective covering.
3. If desired, connect the terminal “Temp. Sensor” to the temperature sensor according to the description “Option Temperature Sensor”.
4. Connect the terminal “Sense In +” from the sensor line directly to the positive pole of the starter battery. Protect the line by a protective covering and observe the setting according to table 2.
5. Connect the terminal „D+ / Kl. 15“ to the existing signal in the vehicle. The D+ signal is preferably to be used for the active alternator. If this signal does not exist (in modern vehicles), the signal “Ignition ON” (terminal 15) can be used for unit control.
6. Connect the starter battery to the terminals „Battery II **IN**“ „-“ and „+“ **observing the correct polarity!** **Reverse battery will destroy the charging converter !**
7. **Charging program OUT Set the** “Battery type” from the board battery (design) **according to table 1.**
8. **Operating Mode, connection type IN Set the** “Input Type” by means of slide switches at the unit rear **according to table 2.**



Absolutely make sure that the two sensor lines “Sense In +” and “Sense Out” are led **separately** and as **separate line** into the + poles of the battery! This is the only way to ensure correct operation and to avoid battery damages!

Provide the sensor lines near the battery with a fuse (cable protection)!



Input and output side of the charging converter are electrically isolated, wit there is no conductive connection between the + and - terminals of the input side (START) and the + and - terminals of the output side (BOARD).



Therefore, it is necessary that the – terminal (Ground) is connected, in accordance with the prescribed cross-section, to the charging converter's battery START side and BOARD side. They also have to be connected with ground / vehicle chassis!

In automatic normal operation, no further operation at the device is necessary.

General connection plan for charging converter, all types:

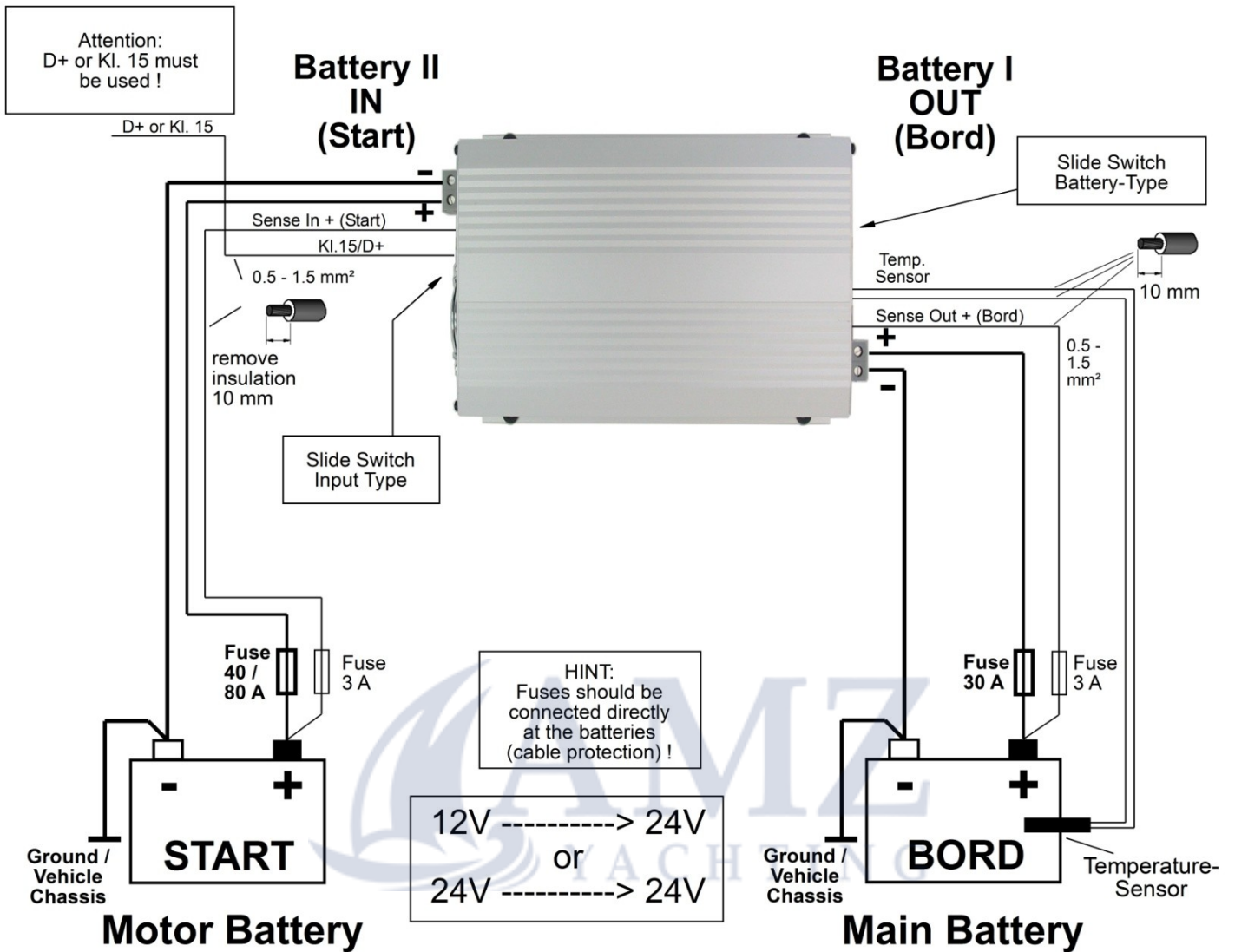

The installation of the device should be done, if the choice is, more closer to the board battery. The unit should always be installed, closer towards the board-battery, if possible.

Follow Cable cross-sections from table Page 5.



Already existing cables cross-sections, which are too small, must be adapted to the minimum requirements in any case!

Fuses have to be adapted to the existing cable cross-sections!

Reverse polarity (+/-) at the IN (Start) side will cause serious damage of the unit!

Recommended cable cross-sections and lengths:

cross-section +/- Pole	VCC 1224-25				VCC 2424-25			
	cable length IN II Motor Batt.	Fuse (A)	cable length OUT I Main Batt.	Fuse (A)	cable length IN II Motor Batt.	Fuse (A)	cable length OUT I Main Batt.	Fuse (A)
4 mm ²	-		1.0 - 3.0 m	30	-		1.0 - 3.0 m	30
6 mm ²	-		2.5 - 5.0 m	30	bis 11.0 m	40	2.5 - 5.0 m	30
10 mm ²	bis 5.0 m	80	4.5 - 10.0 m	30	bis 18.0 m	40	4.5 - 10.0 m	30
16 mm ^{2**}	bis 8.0 m	80	-		-		-	

** use cable without cable end sleeve

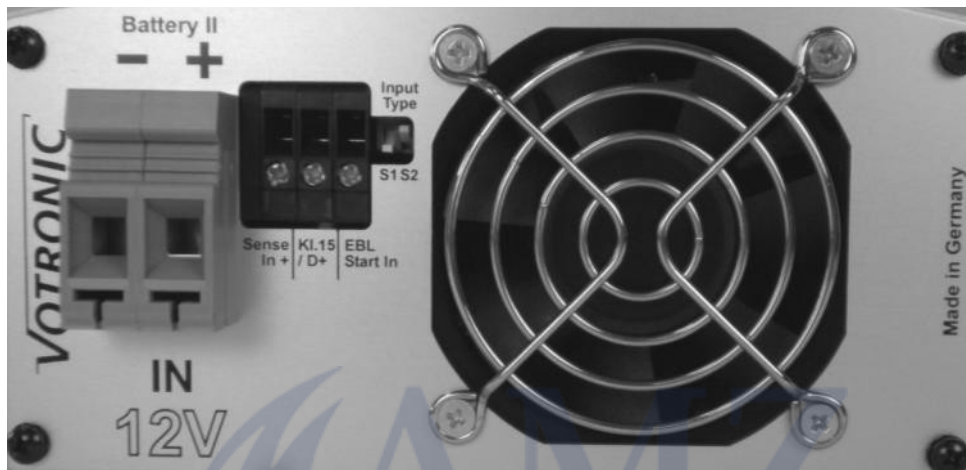

View Input (from Motor Battery)

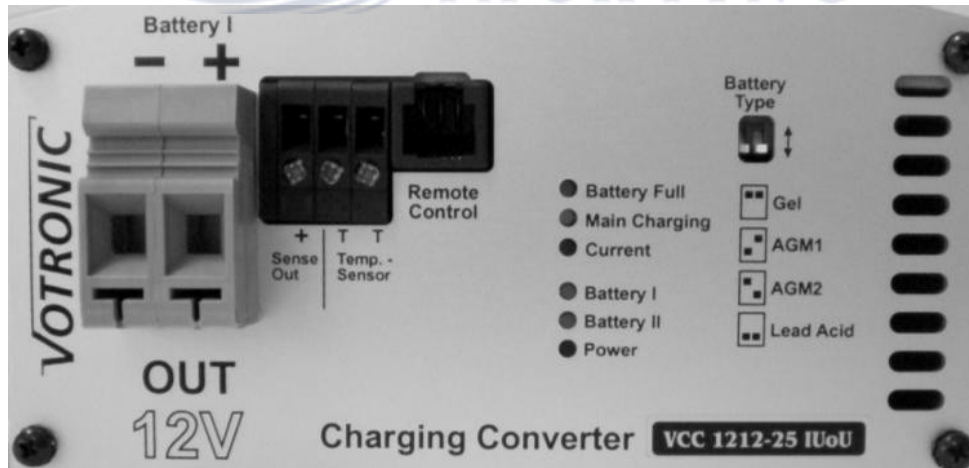

View Output (from Main Battery, shown example 12V)

Option: Temperature Sensor (Temperature sensor 825 required, Order No. 2001):

The temperature sensor controls the **battery temperature of the board battery "OUT"** and the temperature-dependent charging correction. It is connected to the terminals „**Temp. Sensor**“ (any polarity).

Installation Temperature Sensor:

The sensor must have **good thermal contact with the board-battery** (inside temperature). Thus, it should be screwed down to the negative pole of the battery. It is also possible to fasten it centrally on the long side of the battery casing. Ensure that the installation place is not influenced by any source of heat (motor unit, exhaust, heater etc.).

Effect:

The temperature-dependent battery charging voltage will be adapted automatically to the battery temperature (also refer to „**Charging Voltages and Temperature Compensation of the Board Battery**“).

The temperature sensor measures the battery temperature. In case of low temperatures (winter operation), the charging voltage will be increased in order to improve and accelerate full charging of the weak battery. Sensitive consumers are protected by a limitation of the voltage in case of very low outside temperatures.

In case of summery temperatures, the charging voltage is reduced to minimize the load (gassing) of the battery and to extend the lifetime of gas-proof batteries.

Battery Protection (also refer to Characteristic Lines “Charging Voltage Rates and Temperature Compensation”):

In case of high battery temperatures (depending on type: 48 °C or 53 °C) the charging current will be reduced to 50 % for safety reasons. If the battery temperature still continues to rise, a complete disconnection will be effected by the safety relay as soon as the temperature has exceeded 2 °C. The LED „**Main Charging**“ will be **flashing**, but any charging data recorded hitherto will be saved. Automatic charging will be resumed as soon as the temperature drops below the temperature values mentioned above.



The charging converter recognizes automatically a missing sensor, cable break or short-circuit of the sensor lines, as well as unreasonable measuring values. In that case, it will switch to the usual charging voltage rates of 20 °C / 25 °C being recommended by the battery manufacturers.

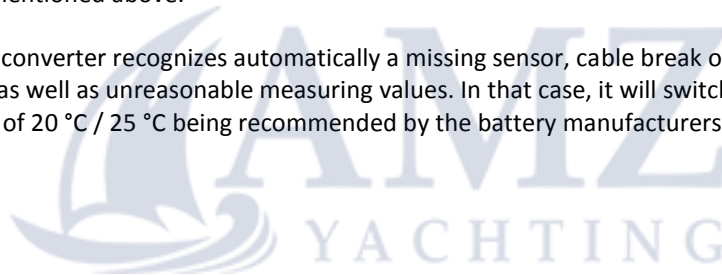

Option: Remote Control (Tip Jack „Remote Control“)

If the charging converter has been installed at a difficultly accessible location, the **Remote Control for Automatic Charger, Order No. 2075**, can be used for complete remote control of the charging process (connection cable of 5 m length being ready for connection is included in the delivery scope).

Connection: Connect the remote control to the tip jack “Remote Control”.

Function: The remote control is equipped with the same pilot lamps (light-emitting diodes) as the charging converter.

Switch Function:

Position „ON“: Charging converter works with full charging capacity.
LED display is active.

Position „OFF“: Charging converter is switched-off (stand-by).



Option: Several Batteries at the Charging output:

Parallel charging of two or more batteries of the same voltage (24 V) is acceptable.

According to the battery manufacturers, **permanent** parallel operation is allowed in case of two or more batteries of the same type (gel/acid/AGM), same capacity, as well as the same age (history) in cross connection.



Table 1: Setting the charging program OUT for type (design) of board battery "I":

Move the **2 slide switches "Battery Type" OUT 24 V** at the front panel to the desired position for **board battery "I"** using a small screw-driver, Factory-adjusted position „Lead Acid“=Lead Acid Battery. The actuating levers are shown in white.









Battery Type Selector Switch	Output Side of the Converter: Unless otherwise specified by the battery manufacturer, the suitable charging program for the battery type (design, technology) can be determined by the following description and technical data (voltage rates U1 and U2, nominal temperature and dwell times U1). Note: The possible parallel/buffering operation with loads connected to the battery is also automatically considered by all charging programs.										
	<p>„Gel“: Charging Program for Lead Gel/Dryfit Batteries: Adjusted to closed, gas-proof Gel batteries with fixed electrolytes, which generally require a higher charging voltage level and longer dwell times U1 to achieve short charging times with particularly high capacity storage and to avoid total discharge, e. g. EXIDE, Sonnenschein dryfit-Start, Dryfit-Sport-Line, DETA Gel Battery Funline, Bosch AS Gel Batteries Va/Z, AS Gel Drive Batteries, AS Gel Lighting Batteries. Unless otherwise specified by the battery manufacturer, this is also recommended for batteries in round cell technology, such as EXIDE MAXXIMA (DC).</p> <p>EXIDE, DETA, VARTA Characteristic Line Gel IU1oU2:</p> <table border="0"> <tr> <td>U1</td> <td>Main/Full Charging:</td> <td>28.80 V</td> <td>20 °C</td> <td>2-8 h</td> </tr> <tr> <td>U2</td> <td>Full/Trickle/Storage Charging:</td> <td>27.60 V</td> <td>20 °C</td> <td>Continuous</td> </tr> </table>	U1	Main/Full Charging:	28.80 V	20 °C	2-8 h	U2	Full/Trickle/Storage Charging:	27.60 V	20 °C	Continuous
U1	Main/Full Charging:	28.80 V	20 °C	2-8 h							
U2	Full/Trickle/Storage Charging:	27.60 V	20 °C	Continuous							
	<p>„AGM 1“: Charging Program for Lead AGM/Fleece Batteries: Adjusted to closed, gas-proof AGM (absorbed glass mat) batteries and batteries in lead-fleece technology requiring a particularly high level U1 for full charging.</p> <p>ATTENTION: It is highly recommended to check the specification sheet of the battery concerning the high charging voltage U1 14.7 V. Unsuitable batteries might age prematurely due to loss of electrolyte!</p> <p>Some manufacturers of AGM / fleece batteries are also prescribing a 14.4 V charging program for charging! In this case, please set „AGM 2“ (14.4 V/13.45 V).</p> <p>Characteristic Line AGM/Fleece AGM 1 IU1oU2:</p> <table border="0"> <tr> <td>U1</td> <td>Main/Full Charging:</td> <td>29.40 V !</td> <td>20 °C</td> <td>0.5-3 h</td> </tr> <tr> <td>U2</td> <td>Full/Trickle/Storage Charging:</td> <td>27.00 V</td> <td>20 °C</td> <td>Continuous</td> </tr> </table>	U1	Main/Full Charging:	29.40 V !	20 °C	0.5-3 h	U2	Full/Trickle/Storage Charging:	27.00 V	20 °C	Continuous
U1	Main/Full Charging:	29.40 V !	20 °C	0.5-3 h							
U2	Full/Trickle/Storage Charging:	27.00 V	20 °C	Continuous							
	<p>„AGM 2“: Charging Program for Lead AGM/Fleece Batteries: Adjusted to closed, gas-proof AGM (absorbed glass mat) batteries and batteries with lead-fleece technology requiring a particularly high 14.4 V level U1 for full charging.</p> <p>Characteristic Line AGM/Fleece AGM 2 IU1oU2:</p> <table border="0"> <tr> <td>U1</td> <td>Main/Full Charging:</td> <td>28.80 V</td> <td>20 °C</td> <td>0.5-4 h</td> </tr> <tr> <td>U2</td> <td>Full/Trickle/Storage Charging:</td> <td>26.90 V</td> <td>20 °C</td> <td>Continuous</td> </tr> </table>	U1	Main/Full Charging:	28.80 V	20 °C	0.5-4 h	U2	Full/Trickle/Storage Charging:	26.90 V	20 °C	Continuous
U1	Main/Full Charging:	28.80 V	20 °C	0.5-4 h							
U2	Full/Trickle/Storage Charging:	26.90 V	20 °C	Continuous							
	<p>„Lead Acid“: Universal charging program for lead acid/lead-acid batteries: For charging and trickle charge of supply (board) batteries. Ensures short charging times, high charging factor and acid mixing for open standard batteries and closed, low-maintenance, maintenance-free "wet electrolyte", "lead-acid", drive, lighting, solar and heavy duty batteries. Also suitable for recently developed batteries (low-antimonous, batteries with silver-alloy, calcium/calcium or similar) with low and very low water consumption.</p> <p>Universal Characteristic Line IU1oU2:</p> <table border="0"> <tr> <td>U1</td> <td>Main/Full Charging:</td> <td>28.80 V</td> <td>22 °C</td> <td>0.5-5 h</td> </tr> <tr> <td>U2</td> <td>Full/Trickle/Storage Charging:</td> <td>26.80 V</td> <td>22 °C</td> <td>Continuous</td> </tr> </table>	U1	Main/Full Charging:	28.80 V	22 °C	0.5-5 h	U2	Full/Trickle/Storage Charging:	26.80 V	22 °C	Continuous
U1	Main/Full Charging:	28.80 V	22 °C	0.5-5 h							
U2	Full/Trickle/Storage Charging:	26.80 V	22 °C	Continuous							

Table 2: Setting of the installation mode/operating mode of Input IN at starter battery "II":

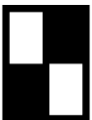
Power Control for Starter Battery and alternator

Move the **2 slide switches** "Input Type" **IN 12 V (24 V)** at the rear panel to the desired position for **starter battery "II"** using a small screw-driver (factory-adjusted position "Little Load").

Input Type Selector Switch	Input Side of the Converter: The operating range of the charging converter must be set for the selected installation- or operating mode, cable length and cross-section, see Functionality of the Power Control for Starter Battery, page 8. For converter protection a battery must be at converters input side. Incorrect setting might cause discharge of the starter battery!									
 S1 S2	<p>A. Minimum load of the starter battery (setting Slave for parallel operation): Because of the high voltage thresholds, only to be used with a separately laid "Sense In +" line, sufficiently dimensioned cable cross-sections and a powerful alternator. In this case, the starter battery will not be discharged under any circumstances; however the switching connection "Kl.15 / D+" must be used.</p> <table border="0"> <tr> <td>Increase of charging capacity:</td> <td>> 13.60 V</td> <td>(27.2 V)</td> </tr> <tr> <td>Reduction of charging capacity:</td> <td>< 13.20 V</td> <td>(26.4 V)</td> </tr> <tr> <td>Switching off threshold charging converter:</td> <td>< 12.60 V</td> <td>(25.2 V) 30 sec.</td> </tr> </table>	Increase of charging capacity:	> 13.60 V	(27.2 V)	Reduction of charging capacity:	< 13.20 V	(26.4 V)	Switching off threshold charging converter:	< 12.60 V	(25.2 V) 30 sec.
Increase of charging capacity:	> 13.60 V	(27.2 V)								
Reduction of charging capacity:	< 13.20 V	(26.4 V)								
Switching off threshold charging converter:	< 12.60 V	(25.2 V) 30 sec.								
 S1 S2	<p>B. Little load of the starter battery (also setting Master for parallel operation): Only use these voltage thresholds with a separately laid "Sense In +" line, sufficiently dimensioned cable cross-sections and a powerful alternator. Note: With continuous signal at connection "Kl.15 / D+" the starter battery might be discharged!</p> <table border="0"> <tr> <td>Increase of charging capacity:</td> <td>> 13.20 V</td> <td>(26.4 V)</td> </tr> <tr> <td>Reduction of charging capacity:</td> <td>< 12.80 V</td> <td>(25.6 V)</td> </tr> <tr> <td>Switching off threshold charging converter:</td> <td>< 12.20 V</td> <td>(24.4 V) 30 sec.</td> </tr> </table>	Increase of charging capacity:	> 13.20 V	(26.4 V)	Reduction of charging capacity:	< 12.80 V	(25.6 V)	Switching off threshold charging converter:	< 12.20 V	(24.4 V) 30 sec.
Increase of charging capacity:	> 13.20 V	(26.4 V)								
Reduction of charging capacity:	< 12.80 V	(25.6 V)								
Switching off threshold charging converter:	< 12.20 V	(24.4 V) 30 sec.								
 S1 S2	<p>C. Without sense line "Sense In +" to the starter battery (also setting Slave for parallel operation): If the cross-sections of the cables to the starter battery are sufficiently dimensioned, separately laid of a "Sense In +" line is not required. A wire jumper must be laid from "IN +" to "Sense In +"! Note: With continuous signal at connection "Kl.15 / D+" the starter battery might be discharged!</p> <table border="0"> <tr> <td>Increase of charging capacity:</td> <td>> 13.40 V</td> <td>(26.8 V)</td> </tr> <tr> <td>Reduction of charging capacity:</td> <td>< 12.80 V</td> <td>(25.6 V)</td> </tr> <tr> <td>Switching off threshold charging converter:</td> <td>< 12.20 V</td> <td>(24.4 V) 30 sec.</td> </tr> </table>	Increase of charging capacity:	> 13.40 V	(26.8 V)	Reduction of charging capacity:	< 12.80 V	(25.6 V)	Switching off threshold charging converter:	< 12.20 V	(24.4 V) 30 sec.
Increase of charging capacity:	> 13.40 V	(26.8 V)								
Reduction of charging capacity:	< 12.80 V	(25.6 V)								
Switching off threshold charging converter:	< 12.20 V	(24.4 V) 30 sec.								
 S1 S2	<p>D. Without sense line "Sense In+" to the starter battery (also setting Master for parallel operation): With short, large dimensioned cross-sections of the cables to the starter battery a separate "Sense In +" line is not required. A wire jumper must be laid from "IN +" to "Sense In +"! Note: Use this setting also for 12V EURO-norm 6, 6 + plus-vehicles (start-/stop-automatic, strong variations of alternator-/starter-battery-voltage in case of energy recuperation etc.). The connection of "Kl.15 / D+" is strongly recommended, either with Kl.15 (Ignition) or better with D+ (alternator runs), because with an continuous signal at connection "Kl.15 / D+" the starter battery might be heavily discharged!</p> <table border="0"> <tr> <td>Increase of charging capacity:</td> <td>> 11.70 V</td> <td>(26.0 V)</td> </tr> <tr> <td>Reduction of charging capacity:</td> <td>< 11.40 V</td> <td>(24.8 V)</td> </tr> <tr> <td>Switching off threshold charging converter:</td> <td>< 11.20 V</td> <td>(23.6 V) 30 sec.</td> </tr> </table>	Increase of charging capacity:	> 11.70 V	(26.0 V)	Reduction of charging capacity:	< 11.40 V	(24.8 V)	Switching off threshold charging converter:	< 11.20 V	(23.6 V) 30 sec.
Increase of charging capacity:	> 11.70 V	(26.0 V)								
Reduction of charging capacity:	< 11.40 V	(24.8 V)								
Switching off threshold charging converter:	< 11.20 V	(23.6 V) 30 sec.								

Parallel Connection for Two Charging Converters:

An increase of the charging capacity for large battery systems can be realized by parallel connection of two units. Couple the connections with each other and define one of the units as "Master" and the second unit as "Slave" according to table 2.



For this operating mode it is absolutely required to use all "Sense" lines and to lead them directly to the batteries. For **EURO norm 6-vehicles set both devices** to the switch position "**D**".

Due to the occurring high current rates, the required cable cross-sections must be doubled, or they must be observed absolutely in case of separate laying.

Start-up and Function Test:

After connecting the charging converter according to description, a function test can be performed.

1. Start the vehicle or switch on ignition (Kl.15).
 - The charging converter will be activated and starts with 10 % of the maximum charging capacity.
 - The LEDs „Power”, „Battery I”, „Main Charging” will be lighting, LED „Current” is lighting dimly.
2. Increase the revolution in the vehicle in order to increase the voltage at the starter battery until it exceeds the adjusted value for the increase of the charging capacity.
 - The charging capacity will be increased and is raised to the maximum value or to the required value of the characteristic line of charging, if the board battery is already full.
 - Depending on the charging current, LED “Current” will glow brighter or darker.

Functionality of the Power Control for Starter Battery and Alternator:

The charging converter is activated by the control input “Kl.15 / D+”, and will be deactivated automatically if the motor is switched-off. It starts with 10 % of its achievable charging capacity.

The setting of the two slide switches “Input Type” at the unit rear (see table 2) now affects the further load of the starter battery circuit supplying current to the charging converter.

After the motor is started, the starter battery shall be charged immediately and its starting capacity shall be maintained. Therefore, the gradual increase of the charging capacity for the board battery will not be effected until the voltage value “increase of the charging capacity” at the starter battery is reached.

In case of strong load on the starter circuit due to many large loads and the starter battery’s voltage drops below the value “reduction of the charging capacity”, such as during motor idling, a gradual reduction of the charging capacity for the board battery will be reduced to relieve the starter circuit. However, the minimum charging capacity will always be 10 % of the achievable charging capacity.

If the voltage drops below the “Switching off threshold charging converter” for 30 sec., the charging converter will be switched-off automatically. As soon as the voltage exceeds the threshold “increase of the charging capacity”, the converter will be switched back on and the capacity will be increased gradually until the required (maximum) charging capacity is reached.

A reduction of the charging capacity by more than 30 % due to insufficient input voltage from the alternator will be indicated by a flashing LED “Batt. II”. The LED will stop flashing as soon as the input voltage is sufficient or when the power requirement has dropped anyway due to a charged board battery “I”.

Indicator Lamps:

„Battery Full“ (Board battery fully charged, **green**):

- If it is lighting: Battery has been charged to 100 %, trickle charge U2, finished.
- If it is flashing: Main charging process is effected in the charging phase U1, indication of charging state of approx. 80 % (short flashing), gradual increase to 100 % (long flashing).
- Off: Main charging process is still being executed in phase I.

„Main Charging“ (Main charging board battery, **yellow**):

- If it is lighting: Main charging process is effected in the charging phase I or U1.
- Off: Trickle charge U2.
- If it is flashing: 1. Battery protection: Battery overtemperature (depending on the type: 50 °C or 55 °C), automatic reset after slight cooling down, or
2. External battery overvoltage > 31.0 V after 20 seconds,
Automatic reset: < 25.5 V after 30 seconds.

„Current“ (Charging Current, **red**):

- The lighting intensity will be **reduced or increased depending on the supplied charging current**.

„Batt. I“ (Board battery, **yellow**):

- If it is lighting: Control and charging of board battery „I“.
- Off: Board battery „I“ is separated from the charging converter (for reasons of safety).

„Batt. II“ (Starter battery, **yellow**):

- If it is flashing: The power control of the charging converter has reduced the output capacity by more than 30 % (starter battery discharge protection, starting capacity is maintained), since the voltage of the starter battery dropped below the adjusted value for “Reduction of the charging capacity” (table 2). The charging capacity will be increased again, as soon as the voltage exceeds the value “increase of the charging capacity”.

„Power“ (Mains, **red**):

- If it is lighting: The charging converter is started and is ready for operation.
- If it is flashing: 1. Disconnection of safety timer, duration of charging phase I was too long (15 hours), too many loads, battery defective (short-circuit of one cell).
Reset only by removal of the signal at D+ / Kl.15 (motor, ignition off).
2. Internal unit failure (overheating), automatic reset after cooling down.
3. Reverse battery of the board battery by mistake (+ and - are mixed up).

Operating Instructions:

- **Interruption of the Charging Process:**

If the control signal D+ or Kl.15 fails or the starter battery is drawn below the adjusted switching off threshold during the charging process, the charging process will be interrupted. The connected batteries **will not be** discharged by the charging converter. Thus, the charging process can be interrupted at any time.

In case of frequent interruptions, particularly before reaching the full charge (LED „Battery Full“ is lighting **permanently**), the battery should be subject to an **occasional full charging cycle of 24 hours** for compensation of the charge.

- **Lifetime of the battery: Partially Discharged Batteries:**

In contrast to other battery types, batteries on lead basis **do not have any** harmful memory effect. Consequently: In case of doubt, partially discharged batteries have to be **charged fully** as soon as possible.

Store only fully charged batteries and recharge them periodically, particularly in case of used (older) batteries and higher temperatures.

- **Lifetime of the battery: Recharge totally discharged batteries immediately:**

Sulphation of the battery plates due to total discharge is to be prevented by **immediate charging**, particularly in case of low and high ambient temperatures. If the grade of sulphation is not too intensive, the battery can recover part of the battery capacity after **several charging/discharging cycles**.

- **Overvoltage limitation at the board battery I (OUT):**

Sensitive loads are protected by a limitation of the charging voltage to max. 30 V during all modes of charging.

- **Overvoltage protection at the board battery I (OUT):**

Charging converters protect themselves against connection of excessive battery voltage rates, or they are switched-off in case of defective additional charging systems (solar systems, generators etc.) switching threshold 31 V, delay 20 s. Reset by battery < 25.5 V or by removal of the control signal D+ or Kl.15.

- **Overvoltage protection at the starter battery II (IN):**

The devices deliver uniform output voltages and currents at input voltages within the EURO standards. Strong surge of the starter battery > 32.2 V leads to shutdown.

- **Overload / Overheating Protection Charging Converter:**

The charging converter is equipped with a double electronic protection against overload and with an automatic protection against adverse installation conditions (e. g. insufficient ventilation, excessive ambient temperatures) by gradually reducing the charging power.

Notice:



Charging Process of the Board Battery:

A new, complete main charging cycle will be executed:

- After a standstill of the alternator or removal of the control signal D+ or KI.15.
 - After the voltage of the starter battery has dropped below the adjusted switching off threshold for more than 30 seconds.
 - If the board battery has been brought down below the battery reset voltage of approx. 25.5V for 30 seconds because of a load that is higher than the charger current.
 - If the charging converter has been switched-off by the remote control and restarted subsequently.
1. Batteries that are completely discharged to 0 V, will be subject to gentle preliminary charging to 16 V with reduced current.
 2. Maximum charging current (**Phase I**) in the mean voltage range from 16 V to the beginning of the phase U1 for short charging times. The LED „Main Charging“ is glowing, and 75-80 % of the capacity will be charged. The duration of phase I depends on the battery conditions, the consumer load and the charging state. The charging converter records the charging process. For safety reasons, phase I will be terminated by the safety timer after 15 hours, at the latest (cell defects etc.).
 3. In case of high battery voltage rates, the charging current will be slightly reduced for battery protection (orientation phase). After that, automatic switching to the following phase U1.
 4. During **Phase U1** (LED „Main Charging“ is glowing) the battery voltage will be kept constantly on a high level. The green LED „Battery Full“ is flashing, and the additional high battery capacity will be charged. The battery charging current is decreased slowly while full charging is increasing. The charging converter controls the charging time as well as the charging current. From these values and from the course of charging being recorded during phase I, the charging converter determines the **100 % full charge point** of the battery for automatic commutation to U2. In contrast to conventional voltage transformers or charging converters with fixed default values for commutation of the charging current, an unnecessary long phase U1 is avoided, which might be caused by consumer load falsifying the charging current. The LED „Main Charging“ will stop glowing.
 5. **Phase U2** (LED „Battery Full“ is glowing permanently): The charging converter has now switched to the lower voltage for trickle charge maintaining 100 % charge of the battery. Only the low compensating recharging current is flowing, which is determined by the battery, and which is required for constant conservation of the full charge.

Note: During the phases U1, U2 (Battery Full) almost the total achievable **charging current** is available for additional supply of loads without any discharge of the battery.

Charging Process Board Battery:

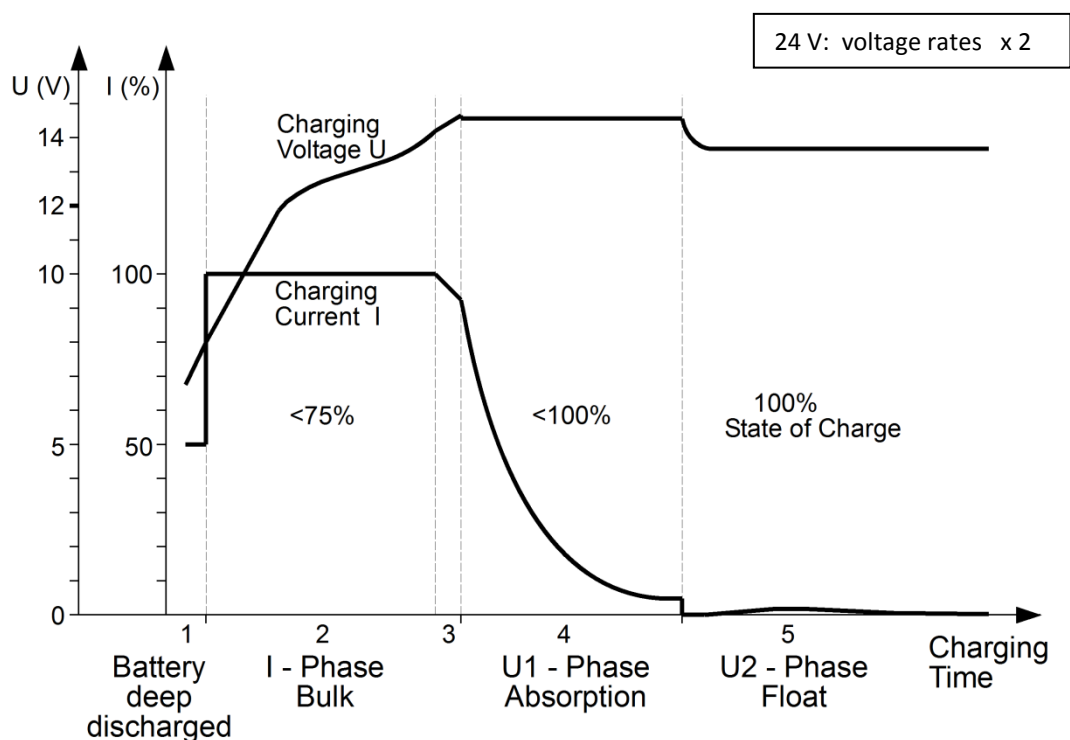

Charging Voltages and Temperature Compensation of the Board Battery:

(In case of 24 V operation: Multiply all indicated voltage rates by 2! TS = Temperature Sensor)

Program „Gel/dryfit“, Characteristic IU1oU2

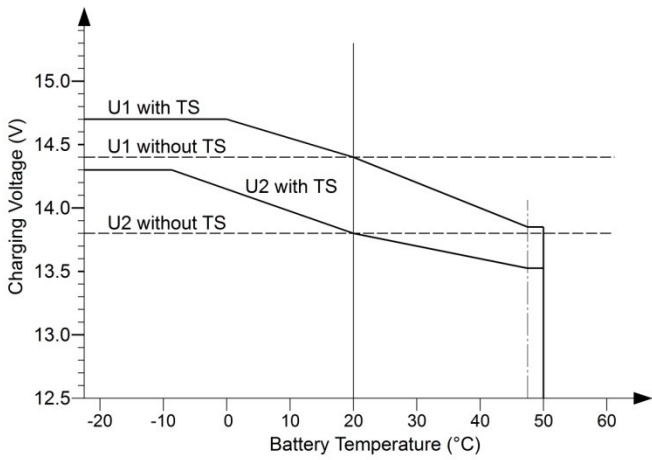

Program „AGM 1 14,7V“, Characteristic IU1oU2

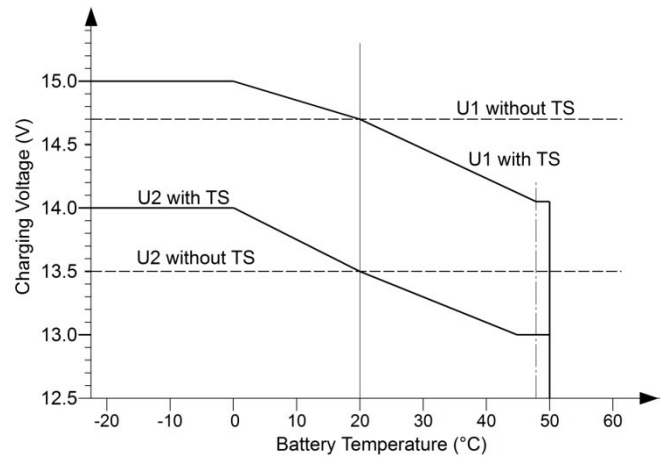

Program „Lead Acid“, Characteristic IU1oU2

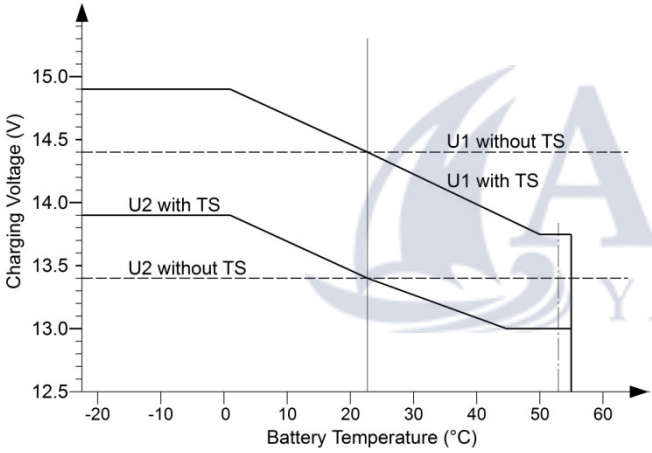

Program „AGM 2 14,4V“, Characteristic IU1oU2

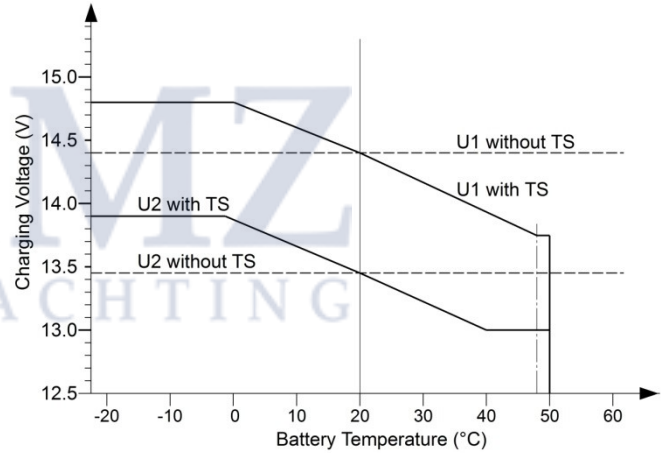

Technical Data	VCC 1224-25 IUoU	VCC 2424-25 IUoU
Input IN Starter Battery "II":		
Nominal Voltage Battery	12 V	24 V
Battery Capacity min.	80 Ah	60 Ah
Power Consumption max.	800 W	800 W
Current Consumption (at lowest input voltage) max.	68 A	33 A
Current Consumption during Stand-by	0.09 A	0.11 A
Current Consumption OFF (D+ or Kl.15 without Signal)	0.0004 A	0.0004 A
Overvoltage Disconnection EURO +	16.50 V	32.20 V
Output OUT Board Battery "I":		
Nominal Voltage Battery	24 V	24 V
Battery Capacity (recommended)	50-170/220 Ah	50-170/220 Ah
Charging Current Main Charging, Phase I, 16 V up to U1, 0-15 h	25 A	25 A
Charging/Buffering/Loading Current, controlled, Phase U1, U2	0 - 25 A	0 - 25 A
Adjust. Charact. Lines of Chrg. AGM2/Gel/AGM1/Lead-acid	4	4
Min. Battery Voltage for Charging Start	0 V	0 V
Prelim. Chrg. Current (totally discharged battery)	12.5 A (0-16 V)	12.5 A (0-16 V)
Reverse Current from Battery, OFF (D+/K1.15 without Signal)	0.000 A	0.000 A
Reset Voltage (30 sec)	25.5 V	25.5 V
Limit of Charging Voltage (Load Protection)	30.0 V	30.0 V
External Overvoltage Disconnection (20 sec.)	31.0 V	31.0 V
Ripple Voltage	<50mV rms	<50mV rms
Input Battery I-Temperature Sensor	yes	yes
Charging Timer 3-fold	3-fold	3-fold
Reverse polarity/short-circuit/back discharge protection	yes	yes
Safety Timer per Charging Phase I- /U1-/ (U2-)	yes	yes
Fitting Position of Unit	any	any
Temperature Range	-20/+45 °C	-20/+45 °C
Speed-controlled, temperature-controlled Fan	yes	yes
Gradual Power Reduction in Case of Overtemperature	yes	yes
Safety Disconnection in Case of Overheating	yes	yes
System of Protection	IP21	IP21
Weight	1700 g	1700 g
Dimensions, incl. Mounting Franges/Feet (mm)	270 x 139 x 74	270 x 139 x 74
Ambient Conditions, Humidity of Air	max. 95 % RH, no condensation	



Declaration of Conformity:

In accordance with the provisions of Directives 2014/35/EU, 2014/30/EU, 2009/19/EC, this product complies with the following standards or normative documents:
EN55014-1; EN55022 B; EN61000-6-1; EN61000-4-2; EN61000-4-3; EN61000-4-4;
EN62368-1; EN50498.



The product must not be disposed of in the household waste.



The product is RoHS compliant. It complies with the directive 2015/863/EU for Reduction of Hazardous Substances in electrical and electronic equipment.



Delivery Scope:

- Charging Converter
- Operating Manual
- Temperature-Sensor 825

Available Accessories:

- Remote Indicator IP67 Order No. 2081
- Remote Control S Order No. 2075

Subject to misprints, errors and technical modification without notice.

All rights reserved, particularly the right of reproduction. Copyright © VOTRONIC 11/2020.

Made in Germany by VOTRONIC Elektronik-Systeme GmbH, Johann-Friedrich-Diehm-Str. 10, 36341 LAUTERBACH/GERMANY

Phone: +49 (0)6641 / 91173-0 Fax: +49 (0)6641 / 91173-10 E-mail: info@votronic.de Internet: www.votronic.de